

A NEW
TOUCH
OF
ELEGANCE
01

A NEW
TOUCH
OF
ELEGANCE
01



Carpanelli è un'azienda "evergreen" che produce mobili di ebanisteria moderna reinterpretando la tradizione in maniera innovativa. Si distingue per la riconoscibilità del suo design e per le lavorazioni di alta ebanisteria. La nostra proposta stilistica sintetizza un equilibrio fra eleganza raffinata e impatto emotivo. Il concetto di lusso viene interpretato come capacità di realizzare soluzioni d'arredo personalizzate che valorizzano la nostra qualità artigianale e cura del dettaglio.

Carpanelli is an "evergreen" company that produces modern cabinet-making furniture by reinterpreting tradition in an innovative way. It stands out for the recognizability of its design and for the high cabinet-making workmanship. Our stylistic proposal synthesizes a balance between refined elegance and emotional impact. The concept of luxury is interpreted as the ability to create customized furnishing solutions that enhance our artisan quality and attention to detail.

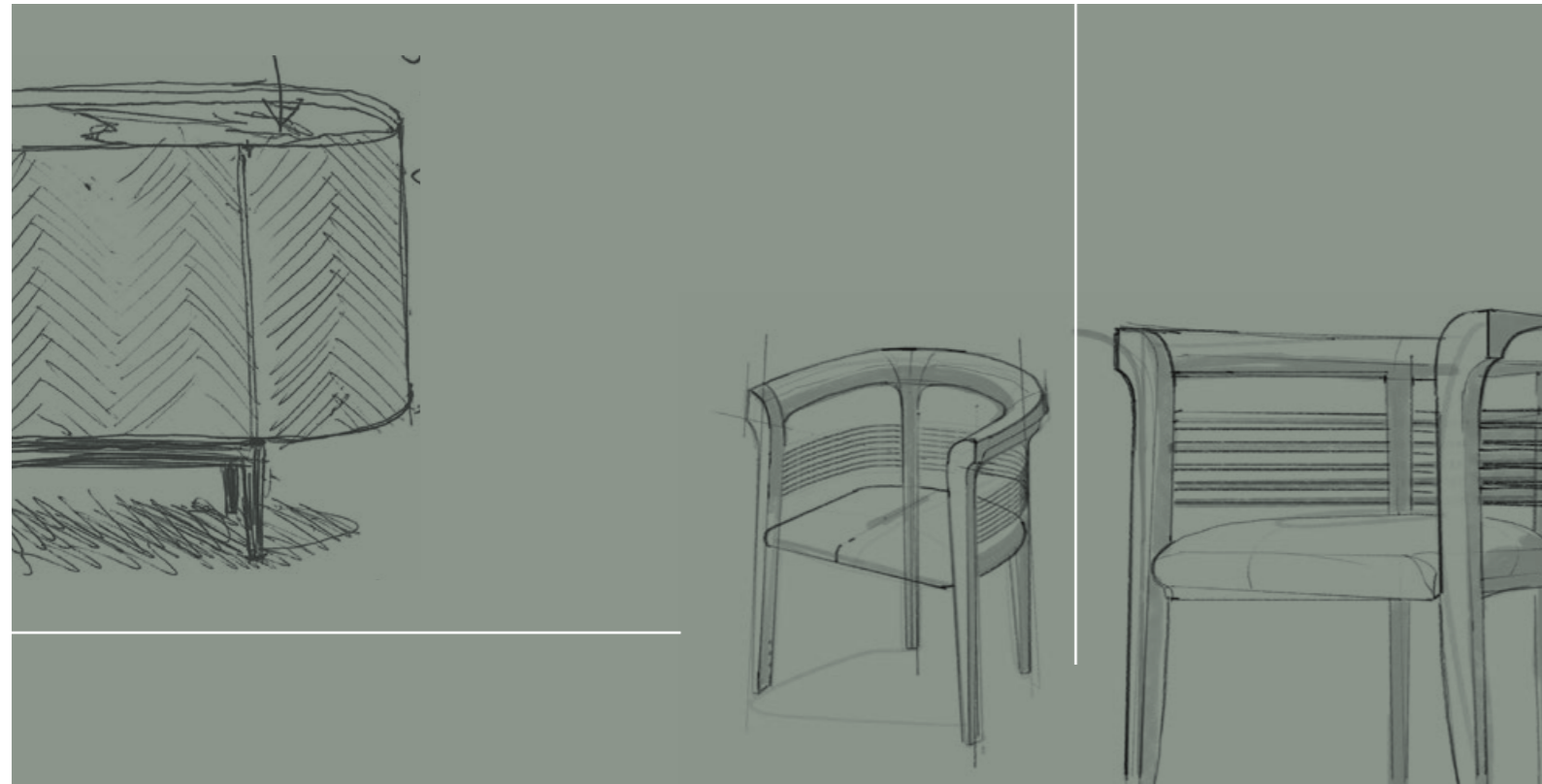

PREMIO **CARPANELLI**

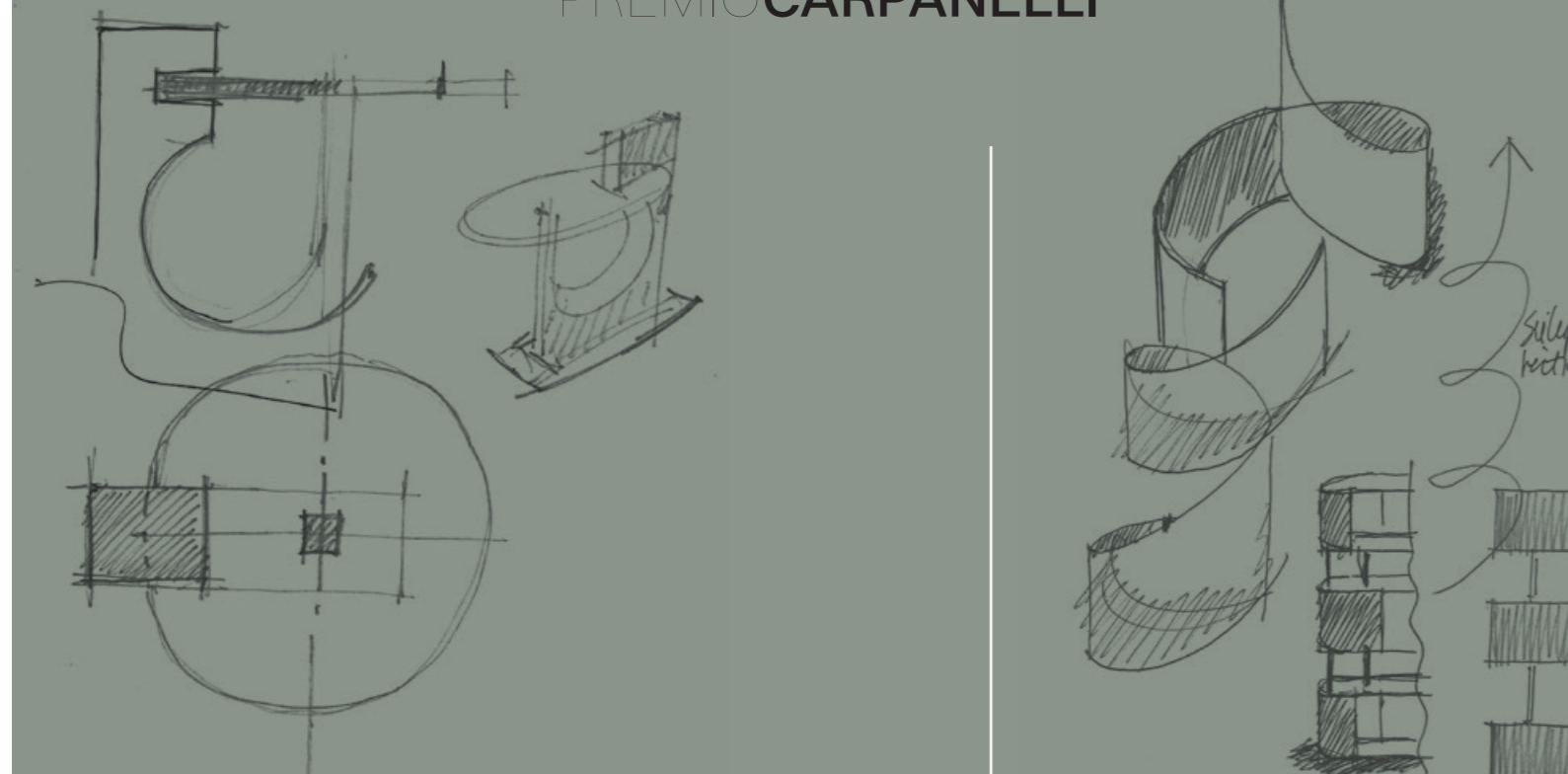

Il Premio Carpanelli Ideasxwood è un concorso internazionale che ci permette di guardare al futuro valorizzando le nostre radici, coniugando tradizione e innovazione.

Progettare un oggetto di design partendo dalla conoscenza e valorizzazione dei legni pregiati è un avvincente percorso progettuale che ha messo alla prova numerosi giovani ed emergenti designers da una parte e studenti provenienti dalle migliori università e accademie di design dall'altra.

Numerosi sono stati i progetti presentati, le migliori proposte sono state selezionate e premiate dalla Giuria. Dei progetti più promettenti sono stati realizzati i prototipi e fanno ora parte delle nostre collezioni ufficiali.

IDEASxWOOD
A CONTEST BY TABU*

The Carpanelli Ideasxwood Award is an international competition that allows us to look to the future by enhancing our roots, combining tradition and innovation.

Designing a design object starting from the knowledge and enhancement of precious woods is a compelling design process that has put numerous young and emerging designers to the test on the one hand and students from the best universities and design academies on the other.

Numerous projects were presented, the best proposals were selected and awarded by the Jury.

Some of the most promising designs have been prototyped and are now part of our official collections.



C CARPANELLI 1919

INDEX COLLECTION ON

6

A NEW TOUCH OF ELEGANCE

È uno stile d'arredo che veste lo spazio con fascino e suggestione, predilige texture morbide al tatto e dall'elevata qualità estetica, abbina legni pregiati, metalli, marmi e finiture materiche; usa pelli, cuoio e tessuti morbidi e materiali opachi, generando spazi sofisticati, per nulla banali seppur minimali.

La scelta dei materiali è un elegante percorso cromatico che attraversa la ricchezza dei toni neutri e naturali.

Si tratta di una esplorazione tattile e materica dalle superfici naturali.

Una raffinata esperienza visiva dettata dalla ricercatezza degli elementi "hand made" e dagli effetti della rifrazione della luce sui materiali naturali.

It's a furnishing style that dresses the space with charm and suggestion, preferring textures that are soft to the touch and with a high aesthetic quality, combining precious woods, metals, marbles and material finishes; it uses leather and soft fabrics and opaque materials, generating sophisticated spaces, not at all trivial even if minimal.

The choice of materials is an elegant chromatic path that crosses the richness of neutral and natural tones.

It is a tactile and material exploration of natural surfaces.

A refined visual experience dictated by the refinement of the "hand made" elements and by the effects of the refraction of light on natural materials.

12 **ALFEA**
Sideboard

28 **GAESYSTEM**
Bookcase

42 **ARA**
Armchair

44 **ARA**
Bergere

48 **THEATER**
Sofa

56 **SHAPE**
Armchair

60 **GAE**
Small table

66 **DOLFIN**
Small armchair

76 **PEGASO**
Consolle/Writing desk

84 **SHAPE**
Table

96 **SHAPE**
Chair

99 **SHAPE**
Small armchair

102 **SIRIO**
Sofa

112 **SEE YE**
Small table

118 **MISTRAL**
Small armchair

124 **SHAPE**
Bed

132 **SHAPE**
Chest of drawers/Bedside table

147 **CORNER**
Small table

147 **CIRCLE**
Small table

149 **SOFIA**
Mirror

136 **TECHNICAL**
DATA

150 **FINISHES**

7

- 1. F223 Salmon lacquered
- 2. F227 Pearl Grey lacquered
- 3. 1195 fabric
- 4. 1197 fabric
- 5. F120 light Tay wood
- 6. ME04 bronze-gold metal
- 7. 1180 Fabric
- 8. CU07 Cord leather "cuio"
- 9. FM07 matt gold Calacatta marble
- 10. 1043 leather
- 11. 477 leather

8 *The materials chosen cross the richness of neutral and natural tones*



ALFEA SIDEBOARD | ARA ARMCHAIR | THEATRE SOFA | CIRCLE SMALL TABLE
CORNER SMALL TABLE | SEE YE SMALL TABLE | CARPANELLI COLLECTION





ALFEA
Sideboard



Sideboard inspired by the volumes of one of the most famous icons of Italian architecture in the world: the Tower of Pisa

IDEASxWOOD
A CONTEST BY TABU*

Credenza dalla linea pulita, rivestita con un intarsio geometrico in legno pregiato, disponibile in Tay Chiaro (CR67), Tay Scuro (CR68) e Noce Canaletto (CR69) e nella versione più piccola a 3 ante (CR73, CR74, CR75). Top contenitore disponibile in vetro verniciato, marmo, cuoio e legno. Profilo del top e frontale cassetti interni rivestiti in cuoio con cucitura. Interno rivestito in Noce Canaletto, ripiani in vetro bronzato. Base in metallo disponibile in finitura bronzo-oro, piombo e brunito

Sideboard with a clean line, covered with a geometric inlay in precious wood, available in light Tay (CR67), dark Tay (CR68) and Canaletto walnut (CR69) and in the smaller version with 3 doors (CR73, CR74, CR75). Container top available in varnished glass, various types of marble, wood and leather "cuoio". Top profile and internal drawer with front covered in leather "cuoio" with stitching. Interior covered in Canaletto walnut, shelves in bronzed glass. Metal base available in bronze-gold, lead and burnished finish.

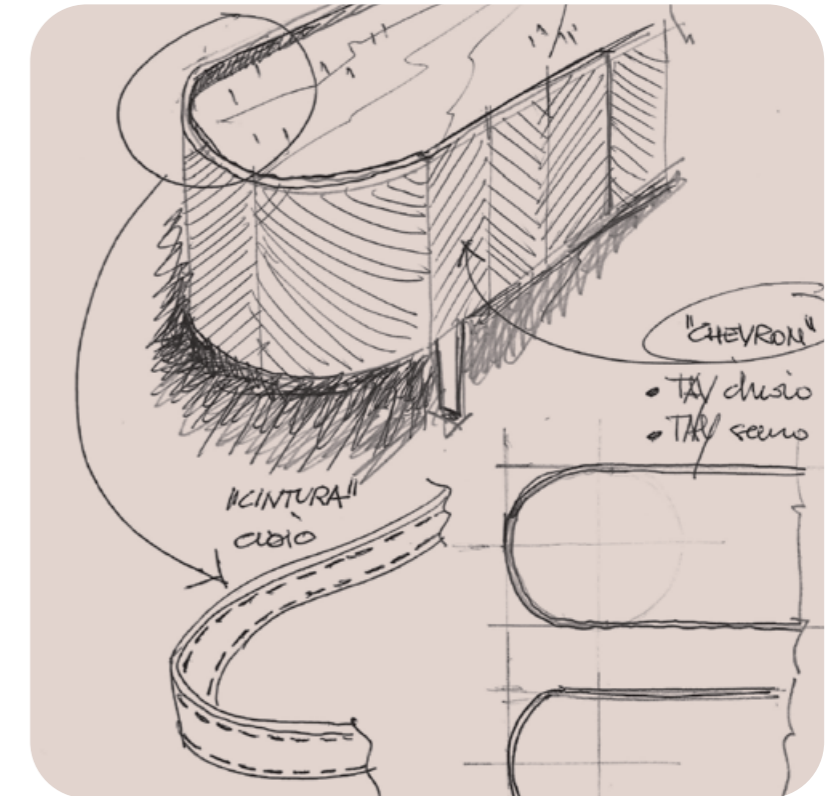

C CARPANELLI 1919

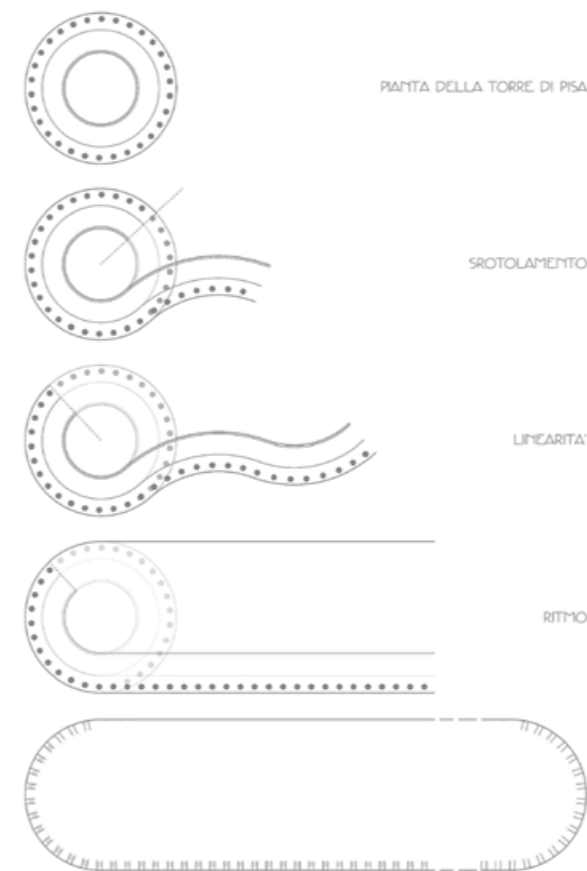

ALFEA
Design by Mattia Fornari
R&S Carpanelli





ALFEA
Sideboard



CR69



CR67



CR68



ALFEA SIDEBORD | CARPANELLI COLLECTION

ALFEA
Sideboard



CR67



CR70B



CR73





ALFEA
Sideboard

Madia alta con intarsio geometrico in legno, con ante o ribalta e cassetti, interno in Noce Canaletto, ripiani interni in vetro bronzato e frontale cassetti interni rivestiti in cuoio. Top in marmo Lepanto verde opaco e profilo in cuoio. Piedini in metallo in finitura bronzo-oro, disponibile anche in finitura piombo e brunito. Disponibile con intarsio in Tay chiaro (CR70, CR70B), Tay scuro (CR71, CR71B) Noce Canaletto (CR72, CR72B).

High sideboard with geometric inlay in wood, with doors or flap door and drawers, interior in Canaletto Walnut, internal shelves in bronzed glass and internal drawer fronts covered in leather "cuoio". Matt green Lepanto marble top and leather "cuoio" profile. Metal feet in bronze-gold finish, also available in lead and burnished finish. Available with light Tay (CR70, CR70B), dark Tay (CR71, CR71B) Canaletto Walnut (CR72, CR72B) inlay.

ALFEA
High sideboard



CR70



CR70B





ALFEA
High sideboard

Top disponibile in varie tipologie di marmo, cuoio, vetro verniciato e legno. Illuminazione interna a richiesta.

Top available in various types of marble, leather "cuoio", varnished glass and wood. Internal lighting on request.



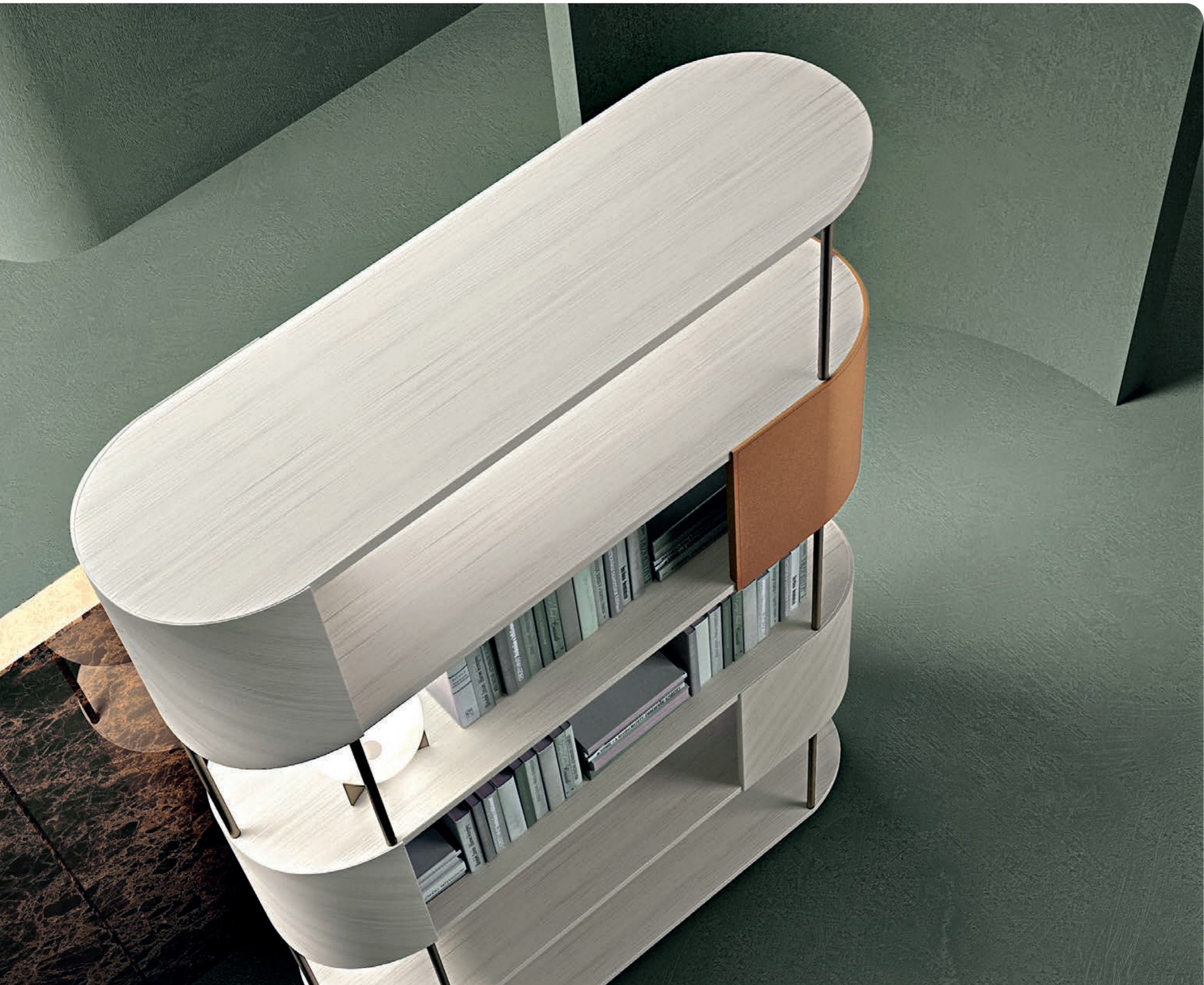

GAESYSTEM
Bookcase



Tay chiaro
Light Tay



GAESYSTEM
Bookcase

Noce Canaletto
Canaletta Walnut



Tay scuro
Dark Tay

GAESYSTEM
Bookcase

Libreria componibile disponibile a misura fissa in due varianti. Si possono anche studiare soluzioni modulari utilizzando i vari elementi come i ripiani a varia lunghezza, elementi curvi e box con antina. Gli elementi metallici sono in finitura oro-bronzo, disponibili anche in finitura piombo o brunito. Essendo bifacciale si presta anche come elemento d'arredo a centro stanza.

Modular bookcase available in fixed size in two variants. Modular solutions can be also studied using the various elements such as shelves of various lengths, curved and box with door. The metal elements are in a gold-bronze finish, also available in a lead or burnished finish. Being double-sided, it is also suitable as a piece of furniture in the center of the room.





36

Madia bifacciale ispirata alla libreria Gae. Presentata in Noce Canaletto, rivestita in cuoio, supporti in metallo disponibili in finitura bronzo-oro, piombo e brunito. Dotata di box apribili. Disponibile anche in Tay chiaro e Tay scuro

Double-sided sideboard inspired by the Gae bookcase. Presented in Canaletta Walnut, covered in leather "cuoio", metal supports available in bronze-gold, lead and burnished finish. Equipped with openable boxes. Also available in light Tay and dark Tay



37



GAE BOOKCASE | BERGERE ARA | POUF ARA | CARPANELLI COLLECTION

GAESYSTEM
Bookcase



ARA
Armchair



Poltrona con struttura interna in legno, imbottitura in poliuretano a quote differenziate e piedini in legno massello tonalità Tay scuro. Disponibile anche in tonalità Noce Canaletto. Rivestimenti disponibili in vari tessuti, pelli e Nabuk.

Armchair with internal wooden structure, polyurethane padding in different densities and solid wood feet in dark Tay tonality. Also available in Canaletto Walnut tonality. Upholstery available in various fabrics, leathers and Nubuck.





ARA
Bergere

Bergere della linea Ara, struttura interna in legno, imbottitura in poliuretano a quote differenziate, piedini in legno massello tonalità Tay scuro, disponibili anche in tonalità Noce Canaletto. In abbinamento pouf imbottito Ara. Rivestimenti disponibili in vari tessuti, pelli e Nabuk.

Bergere from the Ara line, internal structure in wood, padding in multi-density polyurethane, feet in solid wood in dark Tay tonality, also available in Canaletto Walnut tonality. In combination with Ara padded pouf. Upholstery available in various fabrics, leathers and Nubuck.



- 12. 1107 fabric
- 13. F105 Canaletta Walnut
- 14. 1172 fabric
- 15. FV03 Black Moka glass
- 16. CU19 Testa Di Moro leather "cuoio"
- 17. 1132 fabric
- 18. 1232 leather
- 19. CU02 Black leather "cuoio"
- 20. 1133 fabric
- 21. ME06 burnished metal
- 22. FM02 matt Emperor marble

46 *Refined visual
experience dictated
by the refinement
of the "hand made"
elements*





THEATER
Sofa



THEATRE SOFA | CIRCLE SMALL TABLE | CORNER SMALL TABLE | SEE YE SMALL TABLE | CARPANELLI COLLECTION

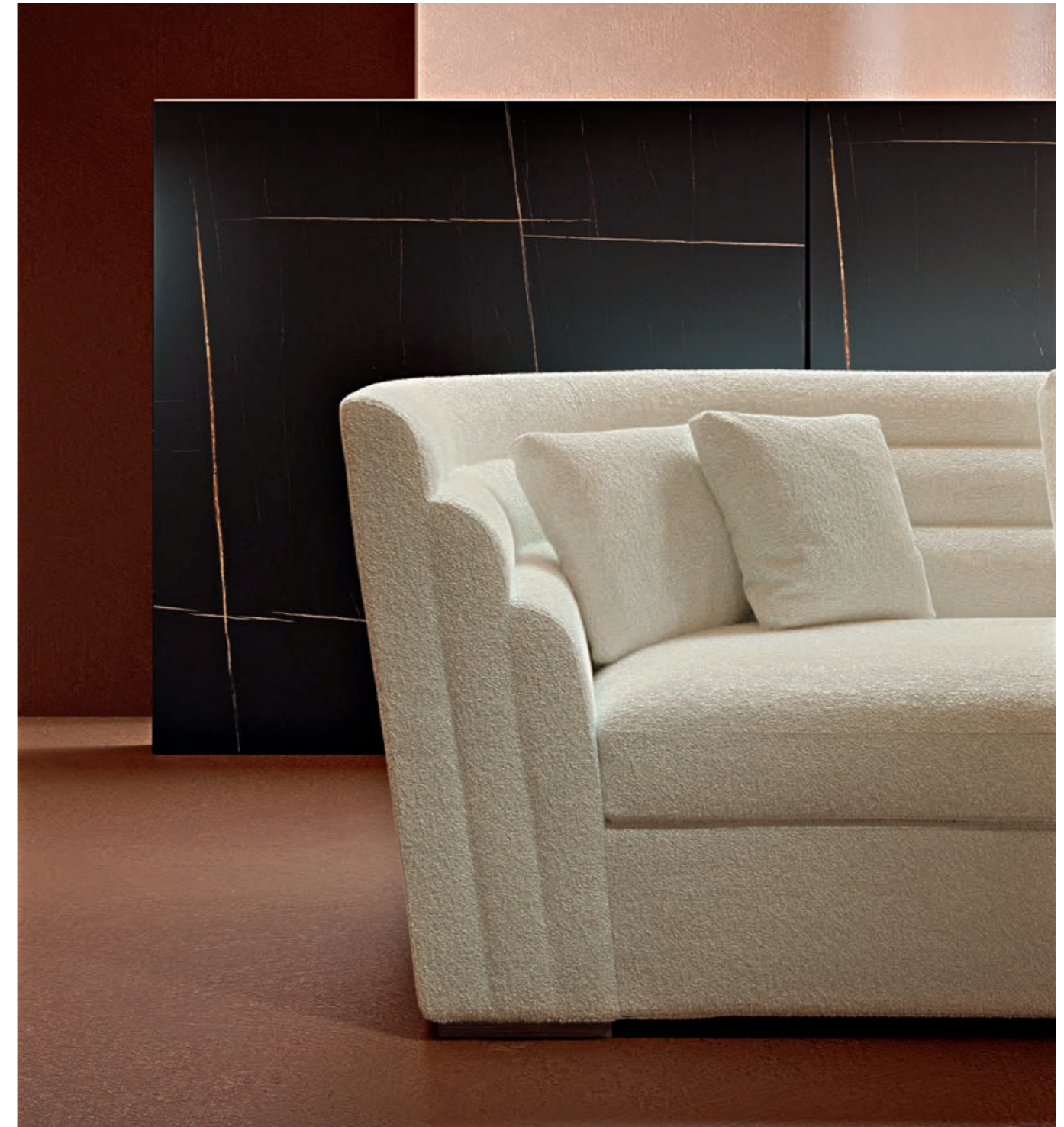

Divano caratterizzato dal design iconico.
Sistema composto da elementi singoli
e vari elementi componibili

Sofa featuring an iconic design. System
composed of single elements and various
modular elements.



THEATRE SOFA | SHAPE ARMCHAIR | GAE SMALL TABLE | POUF THEATRE | SEE YE SMALL TABLE | CARPANELLI COLLECTION



SHAPE

Armchair

Poltrona impreziosita dal dettaglio stilistico che caratterizza la linea Shape, struttura interna in legno, imbottitura in poliuretano a quote differenziate, piedini in legno massello tonalità Tay scuro. Disponibile anche in tonalità Noce Canaletto. Rivestimenti disponibili in vari tessuti, pelli e Nabuk.

Armchair enriched by the stylistic detail that characterizes the Shape line, internal structure in wood, padding in polyurethane of different densities, feet in solid wood in the dark Tay tonality. Also available in Canaletto Walnut tonality. Upholstery available in various fabrics, leathers and Nubuck.



Rivestimento in pelle
Gambe in tonalità Noce Canaletto
Leather upholstery
Legs in Canaletto Walnut tonality



Rivestimento in tessuto
Gambe in tonalità Tay scuro
Fabric upholstery
Legs in dark Tay tonality



SHAPE
Armchair

GAE
Small table



GAE
Small table



Serie di tavolini ispirati alla libreria Gae caratterizzati da elementi curvi disponibili in Tay chiaro, Tay scuro, Noce Canaletto e cuoio. Il top è disponibile in diverse tipologie di marmo, legno e cuoio. Supporti in metallo sono presentati finitura bronzo-oro, disponibili anche in finitura piombo e brunito.

Series of coffee tables inspired by the Gae bookcase characterized by curved elements available in light Tay, dark Tay, Canaletta Walnut and leather "cuoio". The top is available in different types of marble, wood and leather "cuoio". Metal supports are presented in bronze-gold finish, also available in lead and burnished finish.



- 23. F222 Grey Beige lacquered
- 24. 1148 fabric
- 25. 1151 fabric
- 26. F128 dark Tay wood
- 27. CU05 Sand leather "cuoio"
- 28. CU08 Seal leather "cuoio"
- 29. F219 White Grey lacquered
- 30. 1167 fabric
- 31. FV02 Tortora glass
- 32. FM08 matt green Lepanto marble
- 33. 1225 leather
- 34. 1192 fabric

64 *Textures that
are soft to the touch
and with a high
aesthetic quality*





DOLFIN
Small armchair



70

La poltroncina è completamente in legno massello caratterizzata da dei sottili profili curvati che ne alleggeriscono il design. Disponibile in finitura Noce Canaletto o nera. Seduta imbottita con rivestimento disponibile in tessuto, pelle e nubuck.

The armchair is completely in solid wood characterized by thin curved profiles that lighten the design. Available in Canaletto Walnut or black finish. Padded seat with cover available in fabric, leather and nubuck.



DOLFIN
Small armchair

71



DOLFIN
Small armchair



Struttura in finitura Noce Canaletto
Structure in Canaletta Walnut finish





DOLFIN
Small armchair



Struttura in finitura nera
Structure in black finish



PEGASO
Console / Writing desk



78

Scrivania caratterizzata da una linea morbida e leggera. Ampio cassetto con meccanismo push and pull, cassettoni con maniglie in metallo nella parte superiore. Frontale cassettoni in Tay scuro, gambe in legno massello tonalità Tay scuro. Disponibile anche la versione in Noce Canaletto. Top rivestito in cuoio, disponibile in più varianti colore.

Writing desk characterized by a soft and light line. Large drawer with push and pull mechanism, small drawers with metal handles in the upper part. Drawer fronts in dark Tay, legs in solid wood in dark Tay tonality. Also available in Canaletto Walnut version. Top covered in leather "cuoio", available in different colors.



PEGASO
Writing desk

79





82

Consolle caratterizzata da una linea morbida e leggera, rivestita in Noce Canaletto (MB67B) con cassetto con meccanismo push and pull. Gambe in legno massello in tonalità Noce Canaletto. Disponibile anche la versione in Tay scuro (MB67). Top in marmo Calacatta oro opaco, disponibili più varianti.

Consolle characterized by a soft and light line, covered in Canaletta Walnut. Large drawer with push and pull mechanism, small drawers with metal handles in the upper part. Drawer fronts in Canaletta Walnut, legs in solid wood in Canaletta Walnut tonality. Also available in dark Tay version. Top in Gold Calacatta marble, available in different variants.

PEGASO
Cosolle



83



SHAPE
Table



ALFEA HIGH SIDEBOARD | SOFIA MIRROR | SHAPE TABLE | SHAPE CHAIR | SHAPE SMALL ARMCHAIR | CARPANELLI COLLECTION



SHAPE

Table

Tavolo ispirato ai tratti decisi dell'architettura primitiva dell'Isola di Pasqua. Caratterizzato da base scultorea rivestita in legni pregiati, disponibile in Tay chiaro (TA70), Tay scuro (TA71) e in Noce Canaletto (TA72). Piano rotondo in vetro trasparente extra chiaro, disponibile anche in varie tipologie di marmo o legno. Base in metallo disponibile in finitura oro-bronzo, piombo e brunito.

Table inspired by the decisive features of the primitive architecture of Easter Island. Characterized by a sculptural base covered in precious woods, available in light Tay (TA70), dark Tay (TA71) and Canaletta Walnut (TA72). Round top in extra clear transparent glass, also available in various types of marble or wood. Metal base available in gold-bronze, lead and burnished finish.



Top
Vetro trasparente
Transparent glass

Base
F105 Noce Canaletto
F105 Canaletta Walnut



Top
F120 Tay chiaro
F120 Light Tay

Base
F120 Tay chiaro
F120 Light Tay



Top
FM07B marmo Calacatta oro
FM07B Gold Calacatta marble

Base
F128 Tay scuro
F128 Dark Tay





Tavolo Shape in Tay scuro con top rettangolare in vetro trasparente

Shape table in dark Tay wood with rectangular top in transparent glass



Tavolo Shape in Tay chiaro con top rotondo in vetro trasparente

Shape table in light Tay wood with round top in transparent glass

SHAPE
Table



Tavolo rotondo Shape con base in Noce Canaletto e top in marmo verde Lepanto

Shape circular table with Canaletta Walnut base and green Lepanto marble top

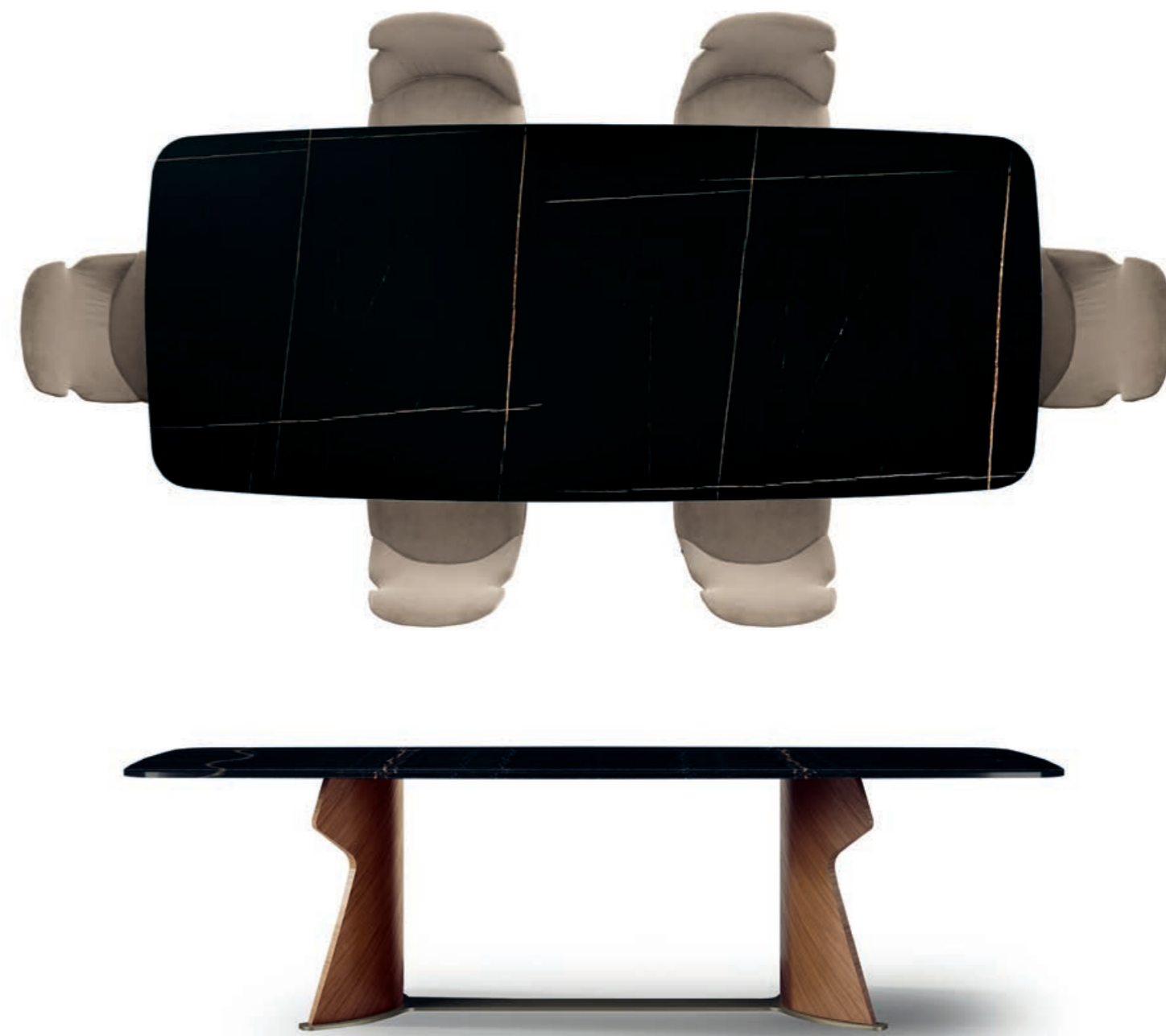

Tavolo rettangolare Shape con base in Noce Canaletto e top in marmo Sahara noir

Shape rectangular table with Canaletta Walnut base and Sahara noir marble top



SHAPE

Chair / Small armchair



SHAPE
Chair / Small armchair



Tonalità Noce Canaletto
Canaletta Walnut tonality

Tonalità Tay scuro
Dark Tay tonality

SHAPE
Chair / Small armchair

Poltroncina impreziosita dal dettaglio stilistico che caratterizza la linea Shape. L'imbottitura è in poliuretano a quote differenziate. La struttura delle gambe è in legno massello disponibile in tonalità Tay scuro e Noce Canaletto.

Armchair embellished by the stylistic detail that characterizes the Shape line. The padding is in polyurethane of different densities. The structure of the legs is in solid wood available in dark Tay and Canaletta Walnut tonality.





SIRIO
Sofa



SIRIO SOFA | SEE YE SMALL TABLE | CIRCLE SMALL TABLE | GAE BOOKCASE | SHAPE ARMCHAIR | CARPANELLI COLLECTION

SIRIO
Sofa



106

Divano modulare componibile con struttura in legno e imbottitura in poliuretano a quote differenziate. La base è rivestita in pelle con cuciture. I piedini in metallo sono disponibili in finitura bronzo-oro, piombo e brunito. Rivestimenti disponibili in tessuto, pelle e nabuk.

Modular modular sofa with wooden frame and polyurethane padding in different densities. The base is covered in leather with stitching. The metal feet are available in bronze-gold, lead and burnished finish. Upholstery available in fabric, leather and nubuck.



107





SIRIO
Sofa

Disponibile in diverse versioni
modulari

Available in different modular
versions





*Emotional
impact and
modern design*

IDEAS x WOOD
A CONTEST BY TABU®

Un progetto nato da una sintesi tra l'ispirazione della mitologia cinese e il design italiano.

A project born from a synthesis between the inspiration of Chinese mythology and Italian design.



SEE Y E

*Design by Jingying Chen
R&S Carpanelli*

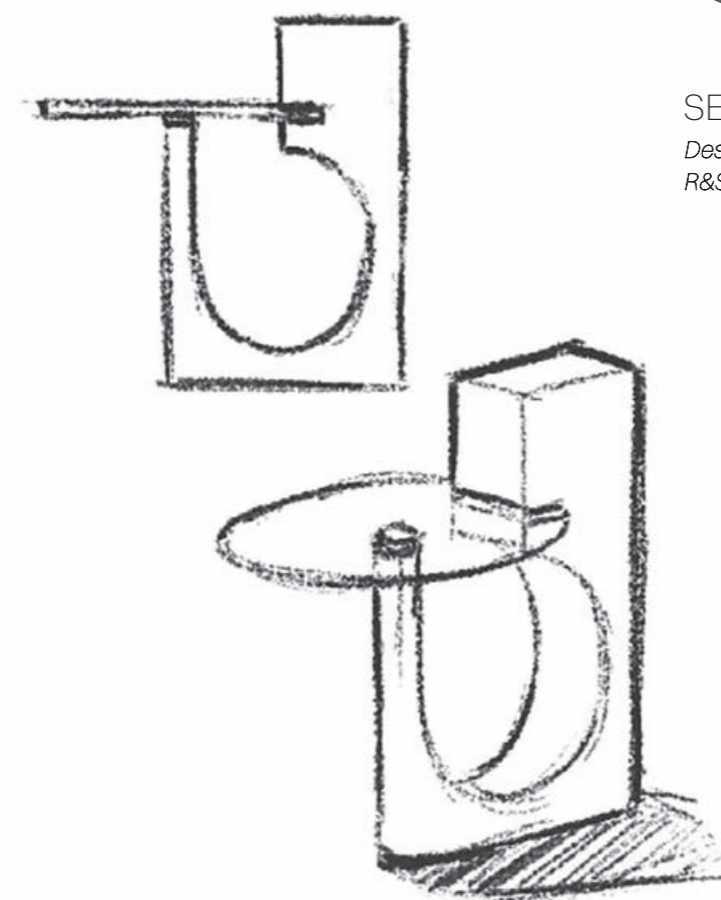



Tavolino dal design iconico, rivestito in Tay chiaro (TL73), Tay scuro (TL74) oppure in versione laccata (TL75). Base in metallo in finitura bronzo-oro, disponibile anche in finitura piombo e brunito. Top in vetro trasparente, disponibile anche in vetro verniciato.

Small table with an iconic design, covered in light Tay (TL73), dark Tay (TL74) or in the lacquered version (TL75). Metal base in bronze-gold finish, also available in lead and burnished finish. Transparent glass top, also available in varnished glass.



SEE YE
Small table

SEE YE
Small table

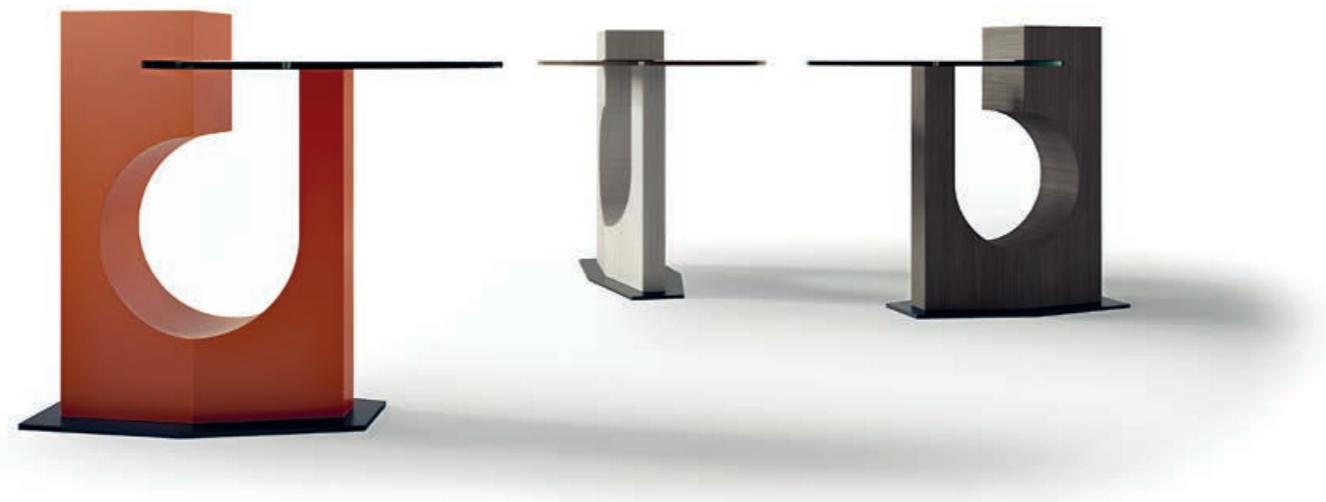



MISTRAL
Small armchair

MISTRAL
Small armchair





MISTRAL
Small armchair

Sedia iconica dalla linea morbida con struttura rivestita in Tay chiaro (SE61), Tay scuro (SE62) e Noce Canaletto (SE63), schienale imbottito disponibile con rivestimento in tessuto, pelle e nabuk.

Iconic chair with a soft line with structure upholstered in light Tay (SE61), dark Tay (SE62) and Canaletto Walnut (SE63), padded backrest available with fabric, leather and nubuck upholstery.





SHAPE
Bed



SHAPE BED | SHAPE CHEST OF DRAWERS | SHAPE BEDSIDE TABLE | CARPANELLI COLLECTION

SHAPE
Bed



Letto con testiera imbottita. Piedini in legno massello in tonalità Tay scuro, disponibile anche in tonalità Noce Canaletto. Disponibile anche la misura King Size. In abbinamento la sua panchetta imbottita. Rivestimenti disponibili in tessuto, pelle e Nabuk.

Bed with upholstered headboard. Feet in solid wood in dark Tay tonality, also available in Canaletto Walnut tonality. Also available in King Size. In combination its padded bench. Upholstery available in fabric, leather and Nubuck.





130

Letto con testiera imbottita, leggermente curvata, impreziosita dal dettaglio stilistico che caratterizza la linea Shape

Padded headboard, slightly curved, embellished by the stylistic detail that characterizes the Shape line



131



SHAPE
Chest of drawers



Comò della linea Shape rivestito in Tay scuro (CO30) o Noce Canaletto (CO30B). Dotato di tre ampi cassetti push and pull e sistema rallenty con interni in cuoio. Top rivestito in cuoio, disponibile in vari colori.

Chest of drawers from the Shape line covered in dark Tay (CO30) or Canaletto Walnut (CO30B). Equipped with three large push and pull drawers and slow motion system with leather "cuoio" interior. Top covered in leather "cuoio", available in various colors.

SHAPE
Bedside table



134

Comodino coordinato alla linea Shape, rivestito in Noce Canaletto (CD34) o in Tay scuro (CD34B). Dotato di cassetto push and pull e sistema rallenty. Top e ripiano in cuoio disponibile in diversi colori.

Bedside table coordinated with the Shape line, covered in Canaletto Walnut (CD34) or in dark Tay (CD34B). Equipped with push and pull drawer and slow motion system. Top and shelf in leather "cuoio" available in different colours.



135

FINISHES
TECHNICAL DATA



ALFEA

Sideboard

Credenza e madia rivestite con intarsio geometrico disponibile in Tay Chiaro, Tay Scuro e Noce Canaletto. Top contenitore disponibile in vetro verniciato, marmo, cuoio e legno. Profilo del top e frontale cassetti interni rivestiti in cuoio con cucitura. Interno rivestito in Noce Canaletto, ripiani in vetro. Base in metallo disponibile in finitura bronzo-oro, piombo e brunito.

Sideboard and high sideboard covered with a geometric inlay in precious wood, available in light Tay, dark Tay and Canaletta Walnut. Container top available in varnished glass, various types of marble, wood and leather "cuoio". Top profile and internal drawer front covered in leather "cuoio" with stitching. Interior covered in Canaletta Walnut, shelves in glass. Metal base available in bronze-gold, lead and burnished finish.

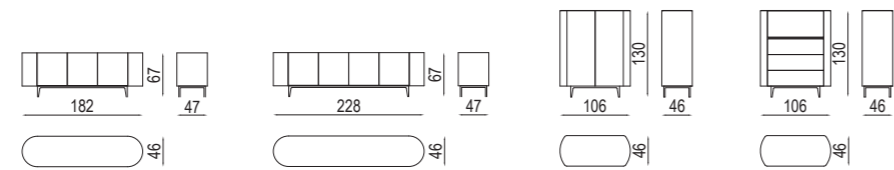

138



FM08 Marmo Verde Lepanto
FM08 Green Lepanto Marble



FM07 Marmo Calacatta Oro
FM07 Gold Calacatta Marble



CU07 Cuoio Corda
CU07 Corda leather "cuoio"

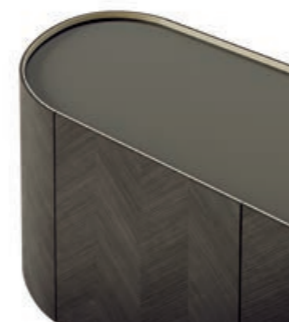

CU08 Cuoio Foca
CU08 Foca leather "cuoio"



F128 Legno Tay Scuro
F128 Dark Tay Wood

SHAPE

Table

Tavolo disponibile in versione rettangolare e rotondo. Base scultorea disponibile in Tay chiaro, Tay scuro e Noce Canaletto. Piano disponibile in vetro, marmo e legno. Base in metallo disponibile in finitura oro-bronzo, piombo e brunito.

Table available in rectangular and round version. Sculptural base available in light Tay, dark Tay and Canaletta Walnut. Top available in glass, marble and wood. Metal base available in gold-bronze, lead and burnished finish.

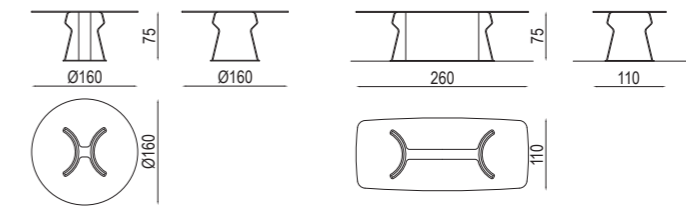

139

GAE SYSTEM

Bookcase / Sideboard

Libreria componibile bifacciale disponibile a misura fissa in due varianti oppure si possono studiare soluzioni modulari utilizzando i vari elementi come i ripiani a varia lunghezza, elementi curvi e box con antina. Gli elementi metallici sono in finitura oro-bronzo, disponibili anche in finitura piombo o brunito. Disponibile anche la versione madia.

Modular double sided bookcase available in fixed size in two variants or modular solutions can be studied using the various elements such as shelves of various lengths, curved and box with door. The metal elements are in a gold-bronze finish, also available in a lead or burnished finish. Also available in the sideboard version.

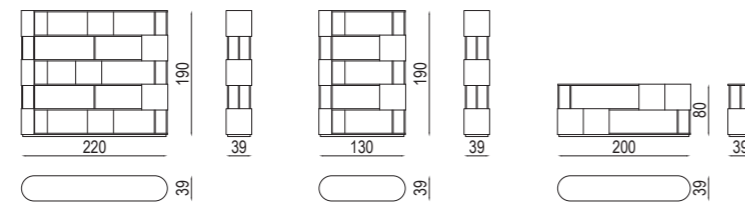

F120 Tay Chiaro
F120 Light Tay

F105 Noce Canaletto
F105 Canaletta Walnut

F128 Tay Scuro
F128 Dark Tay

Libreria disponibile in tre diverse finiture: Tay chiaro, Tay scuro e Noce Canaletto.

Bookcase available in three different finishes: light Tay, dark Tay and Canaletta Walnut.

COMPONIBILITÀ DEL SISTEMA GAE
MODULARITY OF THE GAE SYSTEM

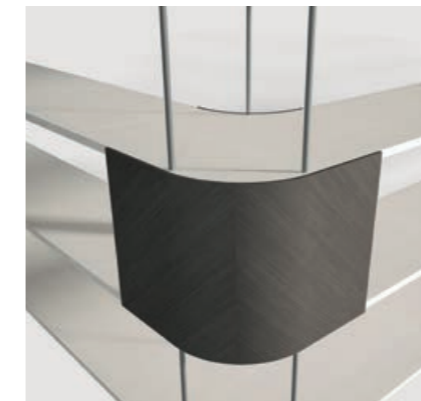

Elemento angolo
Corner element



Elemento terminale con box chiuso
Terminal element with close box



Elemento terminale con box aperto
Terminal element with open box



Elemento terminale A
Terminal element A



Elemento terminale B
Terminal element B



Elemento centrale
Central element

SIRIO

Sofa

Divano con struttura in legno e imbottitura in poliuretano a quote differenziate. La base è rivestita in pelle con cuciture. I piedini sono in metallo finitura bronzo-oro, disponibili anche in finitura piombo e brunito. Rivestimenti disponibili in tessuto, pelle e nabuk. Disponibile a 2, 3 o 4 posti e in diverse versioni modulari.

Sofa with wooden frame and polyurethane padding in different densities. The base is covered in leather with stitching. The feet are in metal with a bronze-gold finish, also available in lead and burnished finish. Upholstery available in fabric, leather and Nubuck. Available with 2, 3 or 4 seats and in different modular versions.

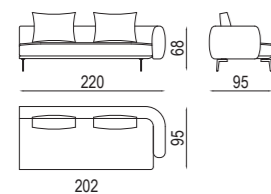
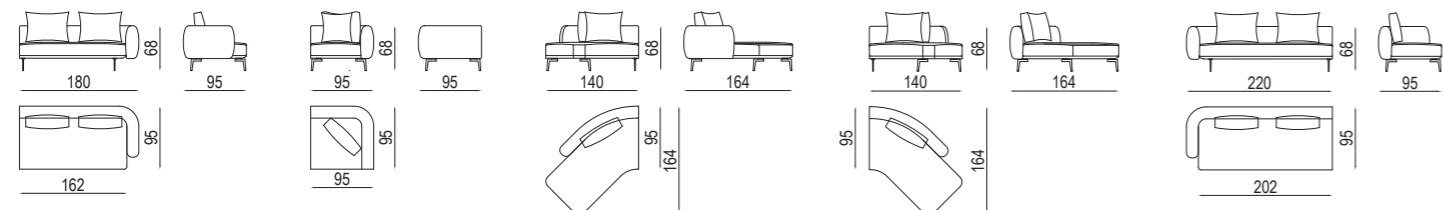
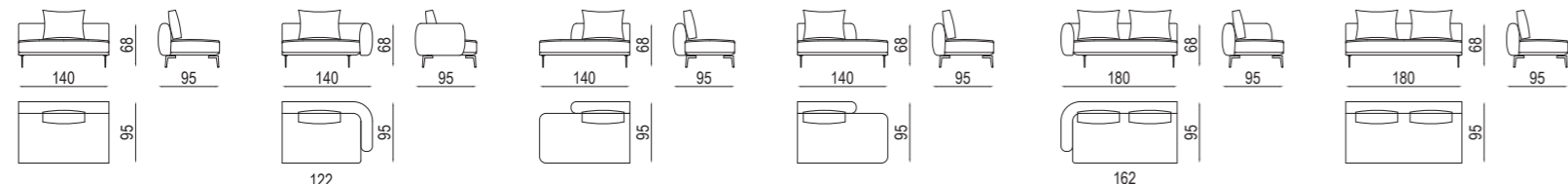
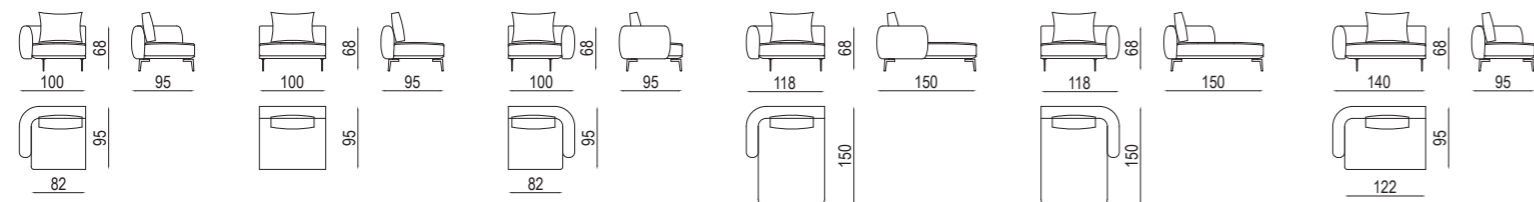
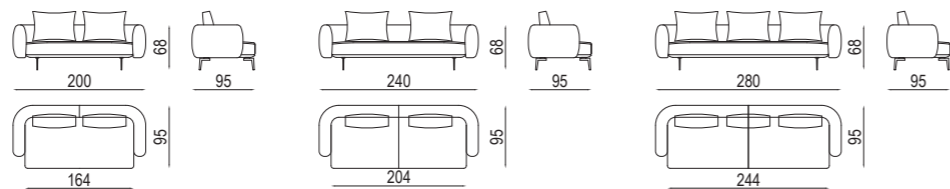

THEATER

Sofa

Divano caratterizzato dal design iconico. Sistema composto da elementi singoli e vari elementi componibili. Struttura in legno rivestito da uno strato di poliuretano a quote differenziate. Il massimo confort della seduta è determinato da un intreccio di cinghie elastiche. I cuscini della seduta sono sfoderabili, realizzati in poliuretano espanso sagomato a quote differenziate rivestito in fodera di cotone. Rivestimento disponibile in tessuto, pelle o nabuk.

Sofa featuring an iconic design. System composed of single elements and various modular elements. Structure in wood covered with a layer of polyurethane of different densities. The maximum comfort of the seat is determined by a weave of elastic belts. The seat cushions have removable covers, made of shaped polyurethane foam in different densities covered in a cotton lining. Upholstery available in fabric, leather or Nubuck.

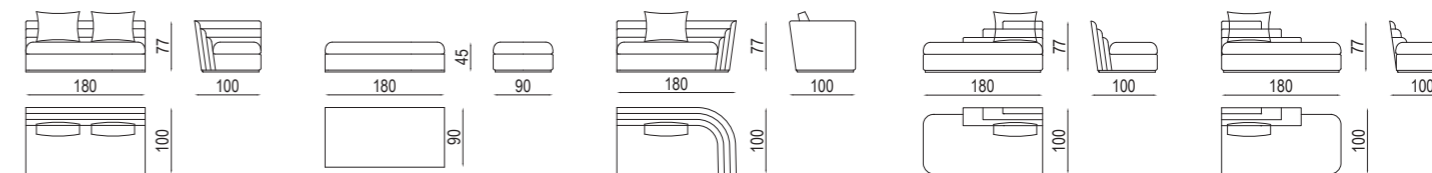
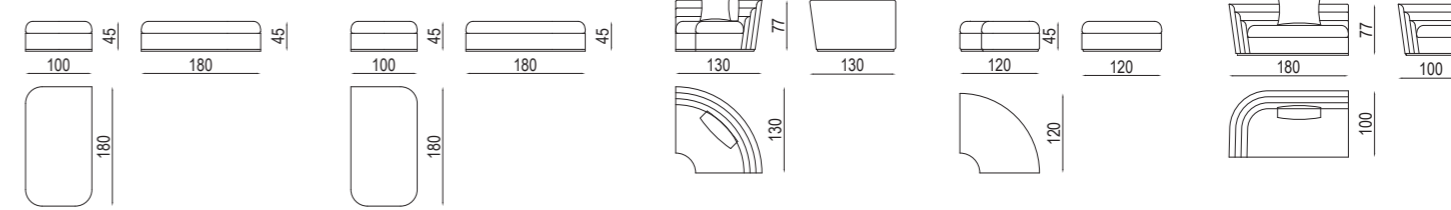
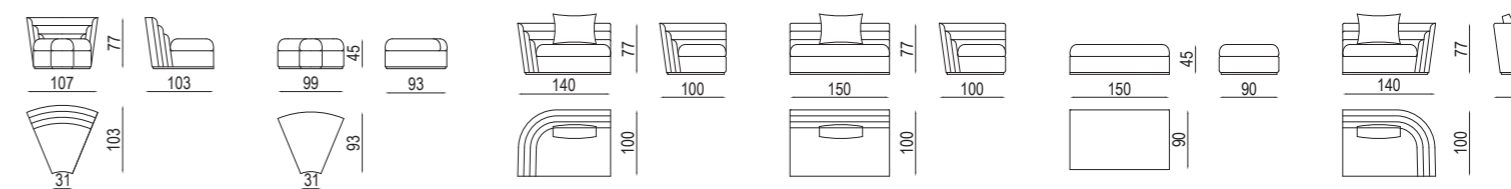
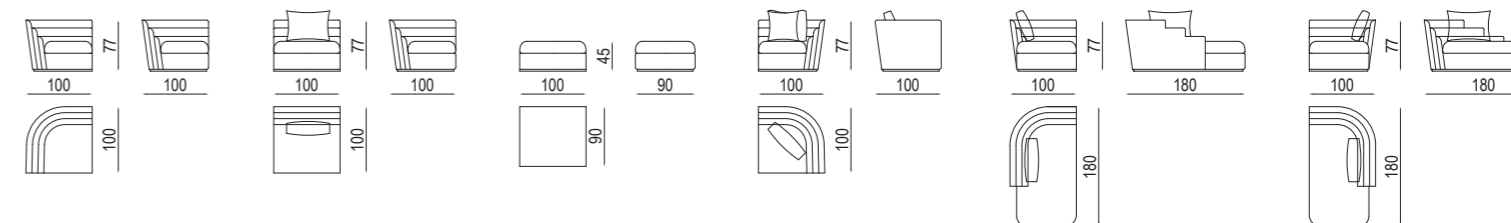
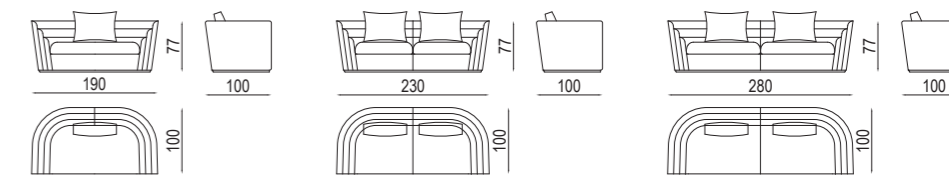

ARA

Bergere

Bergere della linea Ara, struttura interna in legno, imbottitura in poliuretano a quote differenziate, piedini in legno massello tonalità Tay scuro, disponibili anche in tonalità Noce Canaletto. In abbinamento pouf imbottito Ara. Rivestimenti disponibili in vari tessuti, pelli e Nabuk.

Bergere from the Ara line, internal structure in wood, padding in multi-density polyurethane, feet in solid wood in dark Tay tonality, also available in Canaletta Walnut tonality. In combination with Ara padded pouf. Upholstery available in various fabrics, leathers and Nubuck.



SHAPE

Chair / Small armchair

Poltroncina con imbottitura in poliuretano a quote differenziate. La struttura delle gambe è in legno massello disponibile in tonalità Tay scuro e Noce Canaletto.

Armchair with padding in polyurethane of different densities. The structure of the legs is in solid wood available in dark Tay and Canaletta Walnut tonality.



ARA

Armchair

Poltrona con struttura interna in legno, imbottitura in poliuretano a quote differenziate e piedini in legno massello disponibili in tonalità Tay scuro e Noce Canaletto. Rivestimenti disponibili in vari tessuti, pelli e Nabuk.

Armchair with internal wooden structure, polyurethane padding in different densities and solid wood feet available in dark Tay and Canaletta Walnut tonality. Upholstery available in various fabrics, leathers and Nubuck.



DOLFIN

Small armchair

La poltroncina è completamente in legno massello disponibile in finitura Noce Canaletto o nera. Seduta imbottita con rivestimento disponibile in tessuto, pelle e nabuk.

The armchair is completely in solid wood available in Canaletta Walnut or black finish. Padded seat with cover available in fabric, leather and nubuck.



SHAPE

Armchair

Poltrona con struttura interna in legno, imbottitura in poliuretano a quote differenziate, piedini in legno massello disponibile in tonalità Tay scuro e Noce Canaletto. Rivestimenti disponibili in vari tessuti, pelli e Nabuk.

Armchair with internal structure in wood, padding in polyurethane of different densities, feet in solid wood available in the dark Tay and Canaletta Walnut tonality. Upholstery available in various fabrics, leathers and Nubuck.



MISTRAL

Small armchair

Sedia con struttura rivestita disponibile in Tay chiaro, Tay scuro e Noce Canaletto. Schienale imbottito disponibile con rivestimento in tessuto, pelle e nabuk.

Chair with covered available in light Tay, dark Tay and Canaletta Walnut. Padded backrest available with fabric, leather and nubuck upholstery.



GAE

Small table

Serie di tavolini caratterizzati da elementi curvi disponibili in Tay chiaro, Tay scuro, Noce Canaletto e cuoio. Il top è disponibile in diverse tipologie di marmo, legno e cuoio. Supporti in metallo disponibili in finitura bronzo-oro, piombo e brunito.

Series of small tables characterized by curved elements available in light Tay, dark Tay and Canaletta Walnut and leather "cuoio". The top is available in different types of marble, wood and leather "cuoio". Metal supports available in bronze-gold, lead and burnished finish.

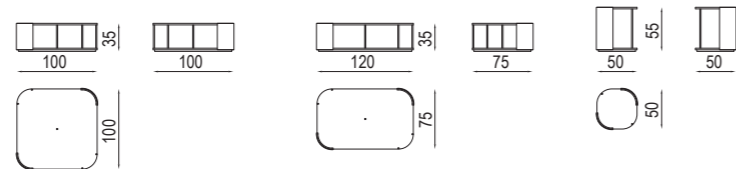

CORNER

Small table

Tavolino con top triangolare. La struttura è disponibile in Tay chiaro e Tay scuro. La base in metallo è disponibile in finitura bronzo-oro, piombo e brunito. Top disponibile in varie tipologie di marmo.

Small table with triangular top. The structure is available in light Tay and dark Tay. The metal base is available in a bronze-gold, lead and burnished finish. Top available in various types of marble.

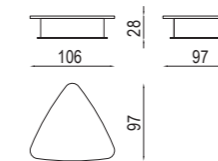

SEE YE

Small table

Tavolino rivestito in Tay chiaro, Tay scuro oppure in versione laccato. Base in metallo disponibile nella finitura bronzo-oro, piombo e brunito. Top disponibile in vetro trasparente e vetro verniciato.

Small table covered in light Tay, dark Tay or in the lacquered version. Metal base available in bronze-gold, lead and burnished finish. Top available in transparent glass and varnished glass.

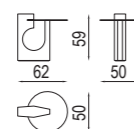

CIRCLE

Small table

Tavolino circolare con intarsio geometrico a raggiera disponibile in Tay chiaro e Tay scuro. Piedini in metallo disponibili in finitura bronzo-oro, piombo e brunito.

Circular small table with geometric radial inlay available in light Tay and dark Tay. Metal feet available in bronze-gold, lead and burnished finish.

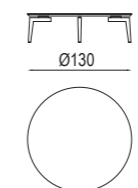

SHAPE

Bed

Letto con testiera imbottita. Piedini in legno massello disponibile in tonalità Tay scuro e Noce Canaletto. Disponibile anche la misura King Size. In abbinamento la sua panchetta imbottita. Rivestimenti disponibili in tessuto, pelle e Nabuk.

Bed with upholstered headboard. Feet in solid wood available in dark Tay and Canaletta Walnut tonality. Also available in King Size. In combination with its padded bench. Upholstery available in fabric, leather and Nubuck.

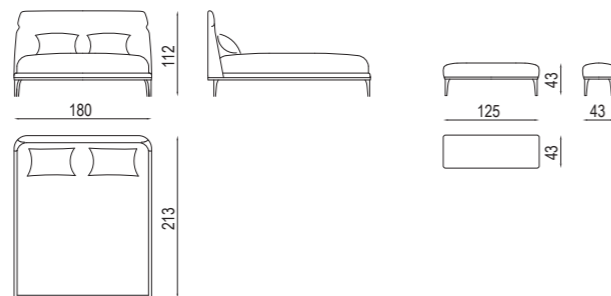

SOFIA

Mirror

Specchiera quadrata e rettangolare con angoli stondati rivestita in cuoio con cucitura. Cuoio disponibile in vari colori.

Square and rectangular mirror with rounded corners covered in leather "cuoio" with stitching. Leather "cuoio" available in various colors.

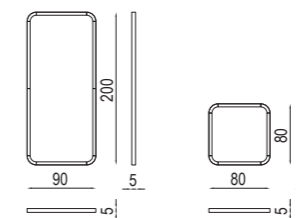

SHAPE

Chest of drawers / Bedside table

Comò rivestito in Tay scuro o Noce Canaletto. Dotato di tre ampi cassetti push and pull e sistema rallenty con interni in cuoio. Top rivestito in cuoio, disponibile in vari colori. Comodino coordinato rivestito in Tay scuro o Noce Canaletto. Dotato di cassetto push and pull e sistema rallenty. Top e ripiano in cuoio disponibile in diversi colori.

Chest of drawers covered in dark Tay or Canaletta Walnut. Equipped with three large push and pull drawers and slow motion system with leather "cuoio" interior. Top covered in leather "cuoio", available in various colors. Bedside table coordinated covered in dark Tay or Canaletta Walnut. Equipped with push and pull drawer and slow motion system. Top and shelf in leather "cuoio" available in different colours.

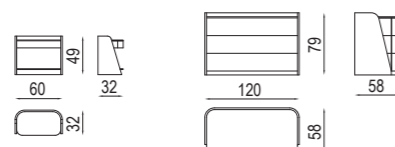

PEGASO

Consolle / Writing desk

Scrivania con ampio cassetto con meccanismo push and pull, nella parte superiore cassettoni con maniglie in metallo. Frontale cassetti in Tay scuro o Noce Canaletto. Gambe in legno massello tonalità Tay scuro o Noce Canaletto. Top rivestito in cuoio, disponibile in più varianti colore. Consolle rivestita in Noce Canaletto o Tay scuro con cassetto con meccanismo push and pull. Gambe in legno massello in tonalità Noce Canaletto o Tay scuro. Top in marmo disponibile in più varianti.

Writing desk with large drawer with push and pull mechanism, small drawers with metal handles in the upper part. Drawer fronts in dark Tay or Canaletta Walnut. Legs in solid wood in dark Tay or Canaletta Walnut tonality. Top covered in leather "cuoio", available in different colors. Writing desk with large drawer with push and pull mechanism, small drawers with metal handles in the upper part. Drawer fronts in Canaletta Walnut or dark Tay, legs in solid wood in Canaletta Walnut or dark Tay tonality. Marble top available in different variants.

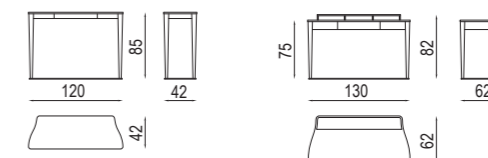

LEGNI | WOOD



F120 Tay Chiaro
F120 Light Tay



F105 Noce Canaletto
F105 Canaletta Walnut



F128 Tay Scuro
F128 Dark Tay

Pregio e caratteristica dei legni tinti è la loro cromaticità cangiante nelle diverse tonalità. Si tratta infatti di una colorazione che viene fatta su tutto il tronco della pianta. Pertanto la tonalità finale del "legno tinto" rispecchia le varie caratteristiche del tronco di ogni singola pianta e delle sue caratteristiche naturali come venature e nodi. Essendo un materiale naturale, con il passare del tempo è soggetto ad un naturale processo di maturazione della tonalità.

Value and characteristic of dyed woods is their iridescent chromaticity in the different tonality. It is in fact a coloring that is done on the whole trunk of the plant. Therefore the final tone of the "dyed wood" reflects the various characteristics of the trunk of each individual plant and its natural characteristics such as veins and knots. Being a natural material, over time it is subject to a natural process of color maturation.

LEGNI INTARSIATI | INLAID WOOD



F120 Tay Chiaro intarsiato
F120 Inlaid light Tay



F105 Noce Canaletto intarsiato
F105 Inlaid Canaletta Walnut



F128 Tay Scuro intarsiato
F128 Inlaid dark Tay

MARMO | MARBLE



FM01B Bianco Carrara opaco
FM01B Matt White Carrara



FM07B Calacatta Oro opaco
FM07B Matt Gold Calacatta

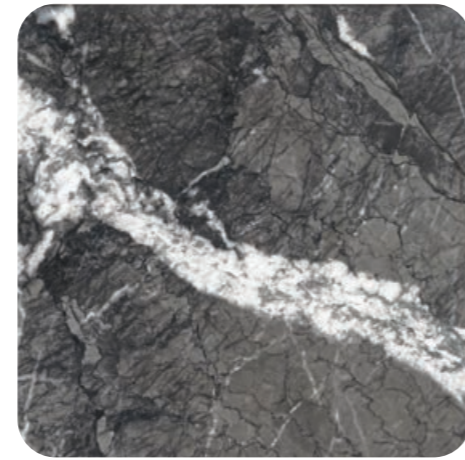

FM05B Grigio Carnico opaco
FM05B Matt Grey Carnic

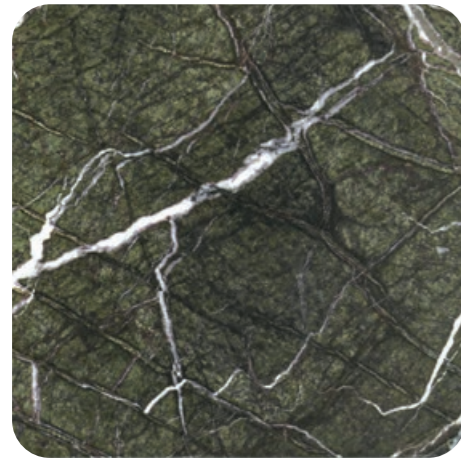

FM08B Lepanto verde opaco
FM08B Matt Green Lepanto

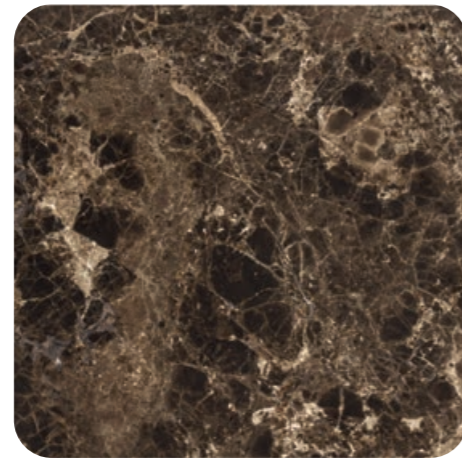

FM02B Emperador opaco
FM02B Matt Emperador

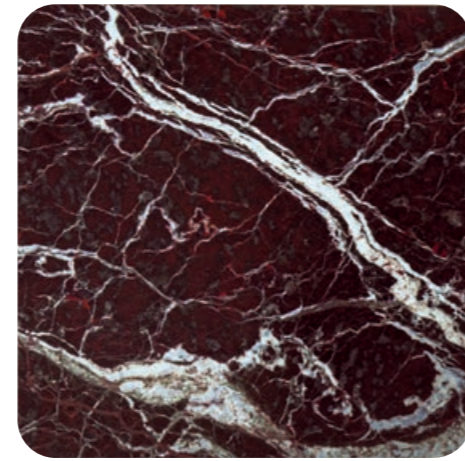

FM09B Lepanto Rosso opaco
FM05B Matt Red Lepanto



FM06B Sahara Noir opaco
FM06B Matt Sahara Noir

CUOIO | LEATHER

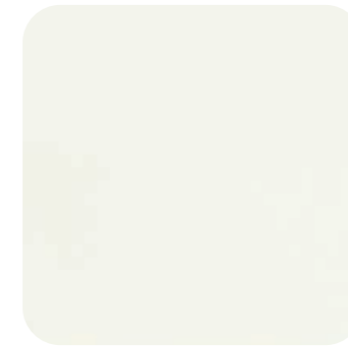

CU04 Bianco
CU04 White



CU07 Corda
CU07 Rope



CU05 Sabbia
CU05 Sand



CU08 Foca
CU08 Seal



CU06 Naturale
CU06 Natural



CU26 Cognac
CU26 Cognac



CU01 Bulgaro
CU01 Bulgarian



CU03 Grigio Scuro
CU03 Dark Grey



CU19 Testa Di Moro
CU19 Dark Brown



CU02 Nero
CU02 Black

LACCATI | LACQUERED



F219 Bianco Grigio
F219 White Grey



F218 Bianco Perla
F218 White Pearl



F220 Grigio Silicio
F220 Silicon Grey



F227 Grigio Perlato
F227 Pearl Grey



F221 Grigio Muschio
F221 Moss Grey



F222 Grigio Beige
F222 Grey Beige



F223 Marrone Arancio
F223 Brown Orange



F226 Salmone
F226 Salmon



F224 Rosso Vino
F224 Red Wine



F225 Verde Scuro
F225 Dark Green

METALLI | METAL



ME06 Brunito
ME06 Burnished



ME04 Bronzo-Oro
ME04 Gold-Bronze



ME05 Piombo
ME05 Lead

VETRI | GLASS



FV02 Tortora
FV02 Dove Grey



FV05 Oro-Bronzo
FV05 Gold-Bronze



FV03 Nero Moka
FV03 Black Moka

A. D.
Euro Sironi
Giuseppe Carpanelli

Graphic designer
Michela Boglietti

Photo
Studio Eleven

Printing
La Grafica-Cantù

Finito di stampare
Gennaio 2023

Carpanelli s.r.l.

via Brescia, 5 - 20832 Desio (MB)

+39 0362 620261

info@carpanelli.com

www.carpanelli.com

